

Technical data sheet

Product features



Fry-top griddle plate 56x55 drop-in electric chromed grooved 400 V

Model	SAP Code	00007463
--------------	-----------------	----------

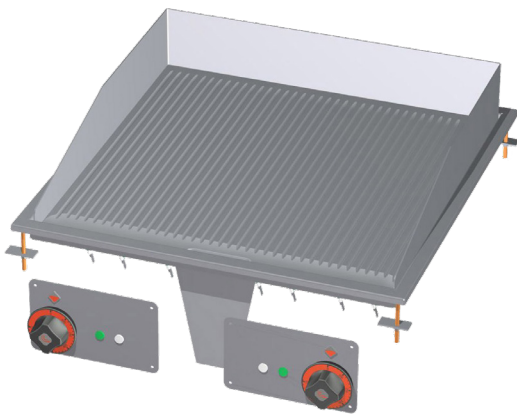

- Top type: Grooved
- Griddle dimensions [mm x mm]: 600 x 600
- Griddle thickness [mm]: 14.00
- Worktop material: Super chrom
- Grid size [mm x mm]: 450 x 595
- Container for liquid fat: Yes
- Independent heating zones: Separate control for each heating zone
- Maximum device temperature [°C]: 300
- Removable rim: Yes

SAP Code	00007463	Loading	400 V / 3N - 50 Hz
Net Width [mm]	600	Griddle dimensions [mm x mm]	600 x 600
Net Depth [mm]	600	Grid size [mm x mm]	450 x 595
Net Height [mm]	220	Top type	Grooved
Net Weight [kg]	45.00	Worktop type	Molded - comfortable cleaning maintenance
Power electric [kW]	6.000		

Technical data sheet

Technical drawing



Fry-top griddle plate 56x55 drop-in electric chromed grooved 400 V

Model

SAP Code

00007463

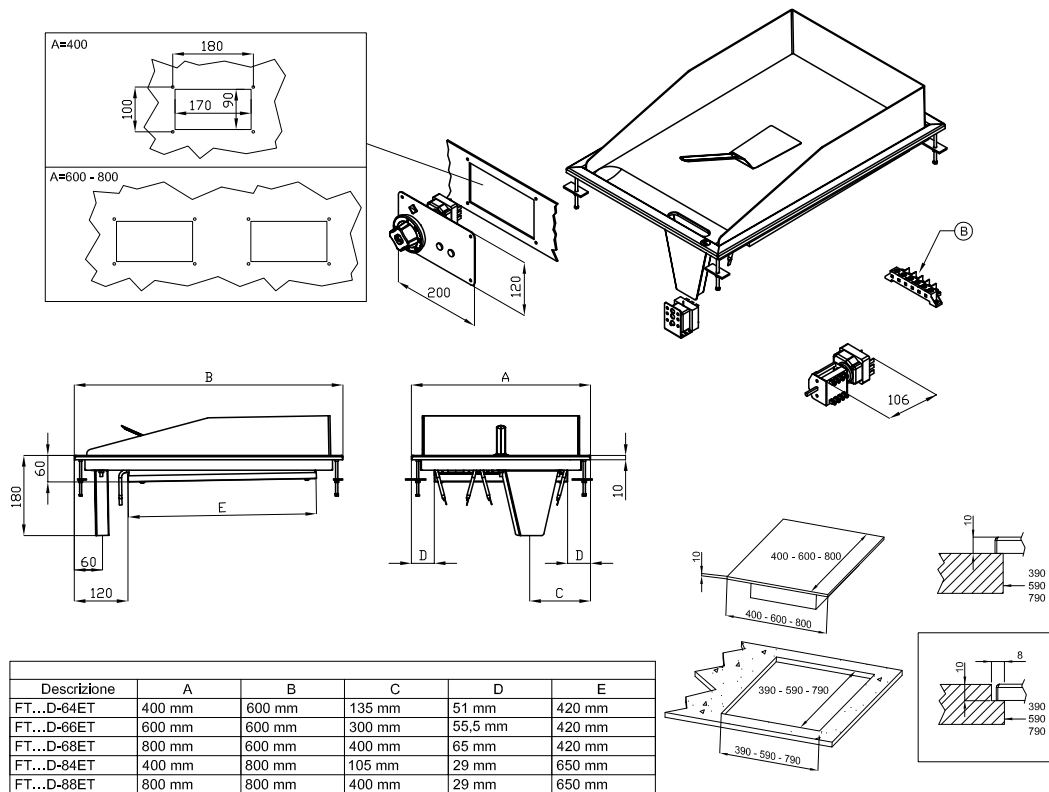

A	Data plate		B	Electrical connection	
---	------------	--	---	-----------------------	--

Technical data sheet

Product benefits



Fry-top griddle plate 56x55 drop-in electric chromed grooved 400 V

Model

SAP Code

00007463

1

All-stainless design

long life
resistance of AISI 304 stainless steel material
the material does not cut

- savings on service interventions
- easier and faster operation

2

Degree of protection of the control elements IPX5

maintenance-free system
resistance to splash water
long life

- savings on service interventions
- easy cleaning and maintenance of equipment

3

Built-in cooking unit

variable use
the possibility of placement in smaller spaces

- easy handling
- cost savings on substructure

4

High detachable hem

better hygienic conditions
preventing grease from splashing onto
ancillary equipment

- easy maintenance
- easy cleaning

5

Grooved plate made of chrome-plated steel

the product bakes less and is easier to clean
a good warming of the meat with a groove

- time-saving in food preparation
- easy preparation of good-looking food

Technical data sheet

Technical parameters



Fry-top griddle plate 56x55 drop-in electric chromed grooved 400 V

Model

SAP Code

00007463

1. SAP Code:

00007463

2. Net Width [mm]:

600

3. Net Depth [mm]:

600

4. Net Height [mm]:

220

5. Net Weight [kg]:

45.00

6. Gross Width [mm]:

730

7. Gross depth [mm]:

630

8. Gross Height [mm]:

470

9. Gross Weight [kg]:

50.00

10. Device type:

Electric unit

11. Construction type of device:

Drop-in

12. Power electric [kW]:

6.000

13. Loading:

400 V / 3N - 50 Hz

14. Protection of controls:

IPX5

15. Device color:

Stainless steel

16. Material:

Stainless steel

17. Indicators:

operation and warm-up

18. Worktop type:

Molded - comfortable cleaning maintenance

19. Worktop material:

Super chrom

20. Worktop Thickness [mm]:

14.00

21. Maximum device temperature [°C]:

300

22. Minimum device temperature [°C]:

50

23. Service accessibility:

Trough the frontal panel

24. Safety thermostat:

Yes

25. Griddle dimensions [mm x mm]:

600 x 600

26. Griddle thickness [mm]:

14.00

27. Container for liquid fat:

Yes

28. Independent heating zones:

Separate control for each heating zone

Technical data sheet

Technical parameters



Fry-top griddle plate 56x55 drop-in electric chromed grooved 400 V

Model	SAP Code	00007463
--------------	-----------------	----------

29. Removable rim:

Yes

31. Top type:

Grooved

30. Grid size [mm x mm]:

450 x 595